



550TCP
Commercial Terrestrial Channel Processor
(For use in NTSC systems)

Instruction Manual

ii Caution Statements

WARNING: TO PREVENT FIRE OR ELECTRICAL SHOCK DO NOT EXPOSE TO RAIN OR MOISTURE

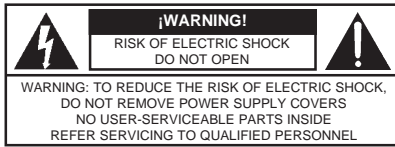

An appliance and cart combination should be moved with care. Quick stops, excessive force and uneven surfaces may cause the appliance and cart combination to overturn.

The lightning flash with arrow head symbol, within an equilateral triangle, is intended to alert the user to the presence of uninsulated "dangerous voltage" within the product's enclosure that may be of sufficient magnitude to constitute a risk of electric shock to persons.

The exclamation point within an equilateral triangle is intended to alert the user to the presence of important operating and maintenance (servicing) instructions in the literature accompanying the appliance.

WARNING: TO REDUCE THE RISK OF FIRE OR ELECTRIC SHOCK, DO NOT EXPOSE THIS APPLIANCE TO RAIN OR MOISTURE. DO NOT OPEN THE CABINET, REFER SERVICING TO QUALIFIED PERSONNEL ONLY.

CAUTION: TO PREVENT ELECTRIC SHOCK, DO NOT USE THIS (POLARIZED) PLUG WITH AN EXTENSION CORD RECEPTACLE OR OTHER OUTLET UNLESS THE BLADES CAN BE FULLY INSERTED TO PREVENT BLADE EXPOSURE.

ATTENTION: POUR PREVENIR LES CHOCS ELECTRIQUES, NE PAS UTILISER CETTE FICHE POLARISEE AVEC UN PROLONGATEUR, UNE PRISE DE COURANT OU UNE AUTRE SORTIE DE COURANT, SAUF SI LES LAMES PEUVENT ETRE INSEREES A FOND SANS EN LAISSER AUCUNE PARTIE A DECOUVERT.

Important Safety Instructions

1. Read Instructions—All the safety and operating instructions should be read before the product is operated.

2. Retain Instructions—The safety and operating instructions should be retained for future reference.

3. Heed Warnings—All warnings on the product and in the operating instructions should be adhered to.

4. Follow Instructions—All operating and use instructions should be followed.

5. Cleaning—Unplug this product from the wall outlet before cleaning. Do not use liquid cleaners or aerosol cleansers. Use a damp cloth for cleaning.

6. Attachments—Do not use attachments that are not recommended by the product manufacturer as they may cause hazards.

7. Water and Moisture—Do not use this product near water—for example, near a bathtub, wash bowl, kitchen sink or laundry tub; in a wet basement; or near a swimming pool; and the like.

8. Accessories—Do not place this product on an unstable cart, stand, tripod, bracket, or table. The product may fall, causing serious injury to a child or adult, and serious damage to the product. Use only with a cart, stand, tripod, bracket, or table recommended by the manufacturer, or sold with the product. Any mounting of the product should follow the manufacturer's instructions, and should use a mounting accessory recommended by the manufacturer.

9. A product and cart combination should be moved with care. Quick stops, excessive force, and uneven surfaces may cause the product and cart combination to overturn.

10. Ventilation—Slots and openings in the cabinet are provided for ventilation and to ensure reliable operation of the product and to protect it from overheating, and these openings must not be blocked or covered. The openings should never be blocked by placing the product on a bed, sofa, rug, or similar surface. This product should not be placed in a built-in installation such as bookcase or rack unless proper ventilation is provided or the manufacturer's instructions have been adhered to.

11. Power Sources—This product should be operated only from the type of power source indicated on the marking label. If you are not sure of the type of power supplied to your home, consult your product dealer or local power company. For products intended to operate from battery power, or other sources, refer to the operating instructions.

12. Grounding or Polarization—This product may be equipped with a polarized alternating-current line plug (a plug having one blade wider than the other). This plug will fit into the power outlet only one way. This is a safety feature. If you are unable to insert the plug fully into the outlet, try reversing the plug. If the plug should still fail to fit, contact your electrician to replace your obsolete outlet. Do not defeat the safety purpose of the polarized plug.

Alternate Warnings—If this product is equipped with a three-wire grounding-type plug, a plug having a third (grounding) pin, the plug will only fit into a grounding-type power outlet. This is a safety feature. If you are unable to insert the plug into the outlet, contact your electrician to replace your obsolete outlet. Do not defeat the safety purpose of the grounding-type plug.

12 a. Mise à la terre ou Polarisation—Cet appareil est équipé avec un cordon d'alimentation à trois fils. Il est à brancher sur une prise ayant un connecteur à la terre. Assurez-vous que la connection à la terre ne manque pas.

13. Power-Cord Protection—Power-supply cords should be routed so that they are not likely to be walked on or pinched by items placed upon or against them, paying particular attention to cords at plugs, convenience receptacles, and the point where they exit from the product.

14. Outdoor Antenna Grounding—If an outside antenna or cable system is connected to the product, be sure the antenna or cable system is grounded so as to provide some protection against voltage surges and built-up static charges. Article 810 of the National Electrical Code, ANSI/NFPA 70, provides information with regard to proper grounding of the mast and supporting structure, grounding of the lead-in wire to an antenna discharge unit, size of grounding conductors, location of antenna-discharge unit, connection to grounding electrodes, and requirements for the grounding electrode. See Figure A.

15. Lightning—For added protection for this product during a lightning storm, or when it is left unattended and unused for long periods of time, unplug it from the wall outlet and disconnect the antenna or cable system. This will prevent damage to the product due to lightning and power-line surges.

16. Power Lines—An outside antenna system should not be located in the vicinity of overhead power lines, other electric light or power circuits, where it can fall into such power lines or circuits.

17. Overloading—Do not overload wall outlets, extension cords, or integral convenience receptacles as this can result in a risk of fire or electric shock.

18. Object and Liquid Entry—Never push objects of any kind into this product through openings as they may touch dangerous voltage points or short-out parts that could result in a fire or electric shock. Never spill liquid of any kind on the product.

19. Servicing—Do not attempt to service this product yourself as opening or removing covers may expose you to dangerous voltage or other hazards. Refer all servicing to qualified service personnel.

20. Damage Requiring Service—Unplug this product from the wall outlet and refer servicing to qualified service personnel under the following conditions:

a. When the power-supply cord or plug is damaged,

b. If liquid has been spilled, or objects have fallen into the product,

c. If the product has been exposed to rain or water,

d. If the product does not operate normally by following the operating instructions. Adjust only those controls that are covered by the operating instructions as an improper adjustment of other controls may result in damage and will often require extensive work by a qualified technician to restore the product to its normal operation,

e. If the product has been dropped or damaged in any way, and

f. When the product exhibits a distinct change in performance—this indicates a need for service.

21. Replacement Parts—When replacement parts are required, be sure the service technician has used replacement parts specified by the manufacturer or have the same characteristics as the original part. Unauthorized substitutes may result in fire, electric shock or other hazards.

22. Safety Check—Upon completion of any service or repairs to this product, ask the service technician to perform safety checks to determine that the product is in proper operating condition.

23. Wall or Ceiling Mounting—The product should be mounted to a wall or ceiling only as recommended by the manufacturer.

24. Heat—The product should be situated away from heat sources such as radiators, heat registers, stoves, or other products (including amplifiers) that produce heat.

NOTE TO CATV SYSTEM INSTALLERS:

THIS REMINDER IS PROVIDED TO CALL THE CATV SYSTEM INSTALLER'S ATTENTION TO ARTICLE 820 - 40 OF THE NEC THAT PROVIDES GUIDELINES FOR PROPER GROUNDING AND, IN PARTICULAR, SPECIFIES THAT THE CABLE GROUND SHALL BE CONNECTED TO THE GROUNDING SYSTEM OF THE BUILDING, AS CLOSE TO THE POINT OF CABLE ENTRY AS PRACTICAL.

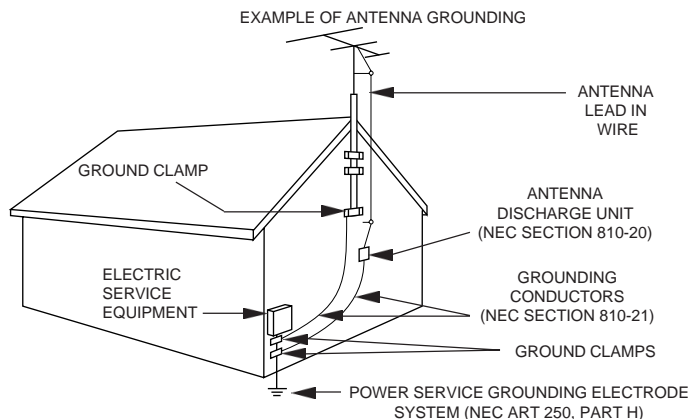

ii	Caution Statements	3	Installation
ii	Important Safety Instructions	4	Installation - List of Input and Output Channels
iv	Specifications	5	T Channel Upconverter
1	Table of Contents - Description	6	Service / If You Need To Call For Help
2	Front Panel Controls and Indicators	7	Warranty
2	Rear Panel Connections		

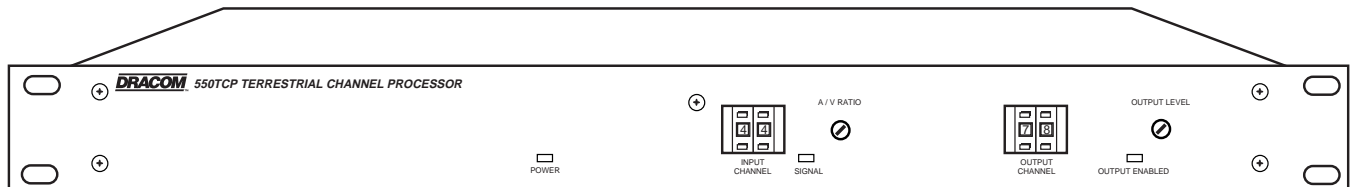

DESCRIPTION

The DRACOM 550TCP is a quality, frequency agile channel processor capable of converting any VHF or UHF, off-air signal to any standard output channel between 54 and 550 MHz. Input and output frequency are easily set with front panel pushwheel switches. A/V ratio and output level controls are also provided along with IF loop-through connections to offer exceptional flexibility.

The synthesized input tuning permits reception of off-air TV channels 2 through 69. A front panel signal indicator lights for input signal strengths greater than a threshold value. RF output level is front panel adjustable to +60 dBmV maximum.

IF loop-thru capability in the 550TCP supplies a padded IF output prior to channel conversion. This feature provides the capability to replace the standard internally generated IF output with an alternate source of composite IF, or allows the insertion of IF scrambling equipment.

Coaxial connectors are provided for the RF Input, the IF Loop-out and Loop-in, and the RF Output. All of the mentioned features, combined with a carefully designed low intermodulation output stage, provide reliable operation in a densely crowded SMATV or cable environment.

The 550TCPT is a 550TCP with a built-in "T" channel upconverter. See page 5 for details.

SPECIFICATIONS

INPUT SECTION

Frequency Range: 54 - 806 MHz: Off-Air TV channels, CH 2-69.
 Input Impedance: 75 Ohms.
 RF Input Level : -10 dBmV to + 35 dBmV.
 Noise Figure: VHF: 8 dB; UHF: 10 dB.
 Tuner Image Rejection: VHF: 65 dB; UHF: 50 dB.

OUTPUT SECTION

Frequency Range: 82 channels, 54 to 550 MHz; Channels 2 to 78 and 95 to 99.
 Output Level: +60 dBmV (typically adjustable from +50 to +60 dBmV).
 Video Frequency Response: 20 Hz to 4.2 MHz, ± 3 dB.
 L-C Delay: ± 50 nSec.
 Frequency Stability: ± 5 PPM of frequency difference between input and output signals.
 A/V Ratio Adjustment: Typically -2 to -12 dB relative to input A/V ratio.
 Spurious Outputs: -58 dBc minimum, -60 dBc typical, (measured at an input level between 0 to +20 dBmV).
 Broadband Noise: -75 dBc typical, (4 MHz noise bandwidth @ ± 12 MHz).

GENERAL

AC Power Input: 115 VAC ($\pm 10\%$), 60 Hz, 30 Watts.
 Operating Temperature: 0° C to +50° C, ambient.
 Size: 19 in. (481 mm) W x 1.75 in. (44 mm) H x 8.75 in. (222 mm) D.
 Weight: 7.0 lbs. (3.2 Kg).

Front Panel Controls and Indicators

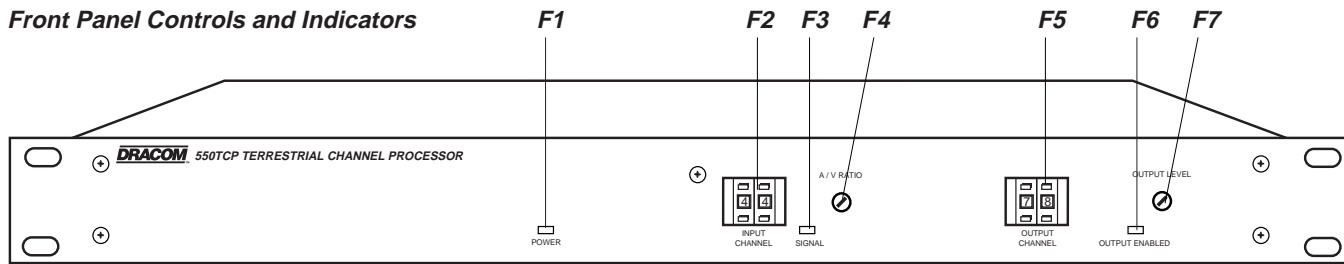

Figure 1

F1 POWER Indicator - Lights when the unit is connected to a source of AC power.

F2 INPUT CHANNEL Number Switch - Sets the input channel number for off air TV channels 02 through 69.

F3 SIGNAL Indicator - Lights to indicate that an input signal is being received as set by the input channel switches and is of a signal strength greater than approximately -10 dBm. Note that if this indicator is off (no received signal), the RF output is switched off. See also Item F6.

F4 A/V RATIO Control - This screwdriver adjustment varies the level of the output aural carrier over a range from -2 to -12 dB relative to the input A/V ratio. The output aural carrier level should be adjusted to approximately 15 dB below the visual carrier level (normal operation). Clockwise rotation increases the output aural carrier level and thus decreases the output A/V ratio.

F5 OUTPUT CHANNEL Number Switch - Sets the output channel number for standard CATV channels 02 through 78 and 95 through 99. See Table 2 - "OUTPUT CHANNEL" in the Installation section of this manual for the corresponding operating frequency, and offset, if any, for each channel number.

F6 OUTPUT ENABLED Indicator - Lights to indicate that a valid channel is selected and an input signal is being received. The RF output is switched off for any invalid output channel settings, no received input signal as set by the input channel switches ('SIGNAL' indicator is off), or other conditions that would cause the unit to operate on an invalid frequency. See also Item F3.

F7 RF OUTPUT LEVEL Control - This screwdriver adjustment varies the RF OUTPUT level. Clockwise rotation increases the level.

Rear Panel Connections

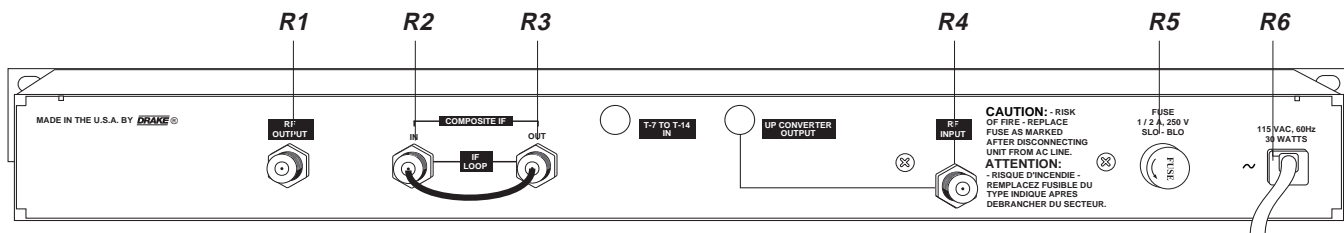

Figure 2

R1 RF OUTPUT - This is the converted channel output.

R2 COMPOSITE IF IN Connector - This is the composite IF input to the output channel circuits. The composite IF has both the aural and visual IF combined. This connection is normally cabled directly to the "COMPOSITE IF OUT" connector (see Item R3). This external IF loop allows the use of accessories such as scramblers or alternate video sources. Note that accessory equipment must also have the visual carrier at 45.75 MHz and the aural carrier at 41.25 MHz. Both input carriers must be at their nominally specified levels.

R3 COMPOSITE IF OUT Connector - This is the composite IF output from the IF circuits. The composite IF provides a vestigial sideband filtered visual carrier at 45.75 MHz (plus or minus any input signal offset) combined with a level controlled aural carrier at 41.25 MHz (plus or

minus any input signal offset). This connection is normally cabled directly to the "COMPOSITE IF IN" connector (see Item R2).

R4 RF INPUT Connector - This is the input to the channel processor circuits for all signals with video carrier frequencies in the range of 54 through 806 MHz.

R5 FUSE Holder - Always replace this fuse with one of the same type and rating: 1/2 Amp, 250 V, SLO-BLO, 5 x 20 mm type.

R6 LINE CORD - This is a three-wire power cable. When the cable is connected to a properly wired AC power line outlet, this cable grounds the instrument cabinet. Connect to a nominal 115 VAC $\pm 10\%$, 60 Hz source. Do not defeat the safety purpose of the attached line cord plug.

CONNECTIONS AND CONTROLS – All connections to and from the 550TCP are made through the rear panel. Figure 3 shows a typical two channel processing installation involving the converting of off-air signals. Additional channels can be processed by using additional channel processor units and either multi-port combiners or combinations of two-port combiners.

INSTALLATION NOTES – Level adjustment provides optimum performance in multichannel installations. The channel processor outputs should be checked periodically with a spectrum analyzer to maintain a ± 1 dB variation of adjacent channel carriers. Aural/Visual (A/V) ratios should be held to -15 dB or less. The 'Output Level' and 'A/V Ratio' controls are used respectively to make these adjustments. If an output level of less than $+50$ dBmV is required, add an attenuator of the appropriate value to the modulator output.

Example: For an output level of $+45$ dBmV, add a 12 dB attenuator pad to the modulator output and set the output level.

RACK MOUNTING – Adequate ventilation is very important in multichannel installations. Units should be spaced apart by at least one panel height wherever possible, and some air movement is advisable in enclosed rack cabinets. Excessive heat will shorten component life and unit performance will be degraded without proper cooling.

FCC PAR.76.612- The synthesizer in the output section of the 550TCP has been programmed to comply with FCC requirements for offsets on cable channel frequencies assigned to aviation and navigation communications. The programmed offset for each channel is listed in Tables 3 and 4 in the Installation section of this manual.

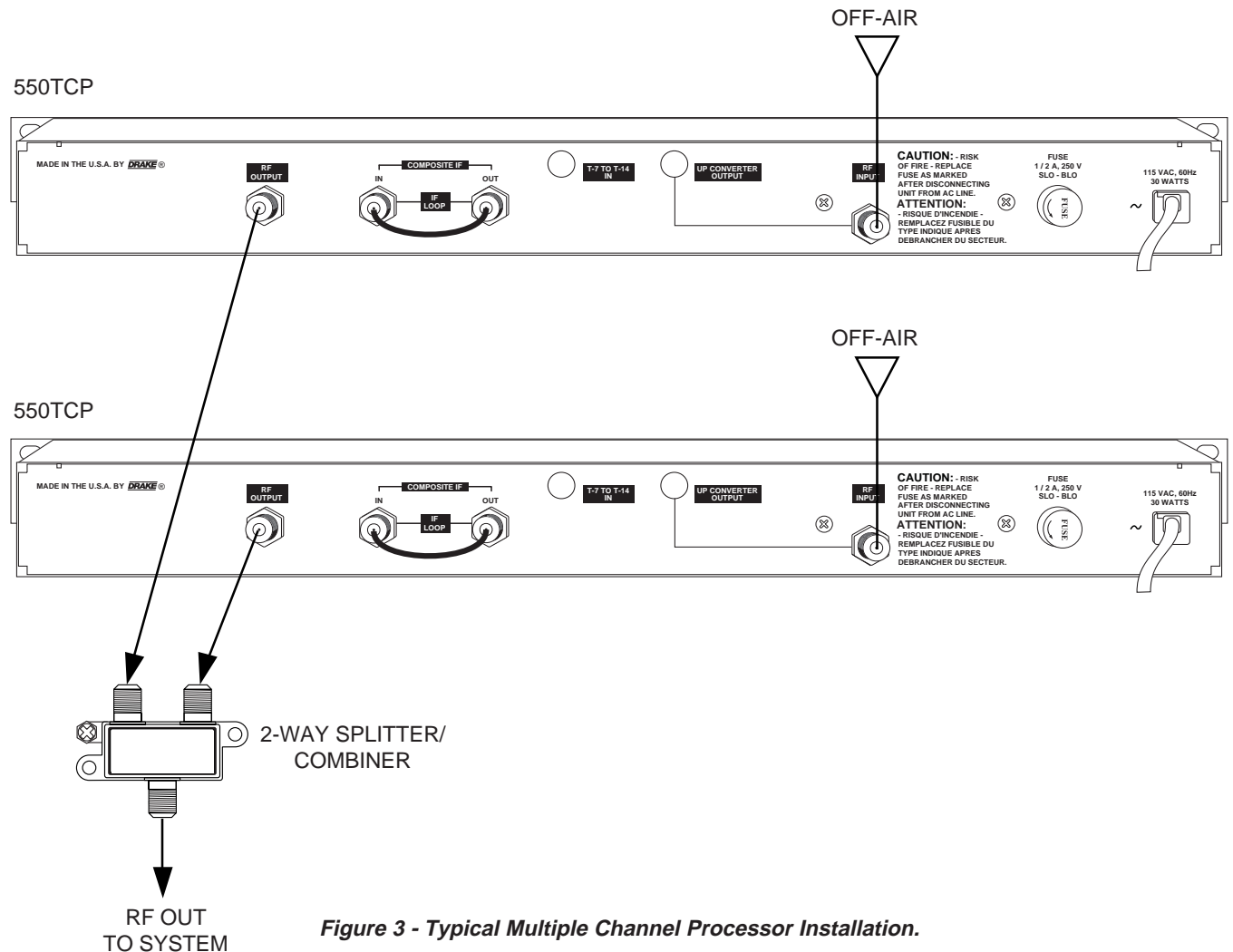

Figure 3 - Typical Multiple Channel Processor Installation.

TABLE 1: INPUT CHANNEL
OFF-AIR (VHF)

VHF BROADCAST CHANNELS	
Channel Number	Visual Carrier Frequency (MHz)
2	55.25
3	61.25
4	67.25
5	77.25
6	83.25
7	175.25
8	181.25
9	187.25
10	193.25
11	199.25
12	205.25
13	211.25

TABLE 2: INPUT CHANNEL
OFF-AIR (UHF)

UHF BROADCAST CHANNELS	
Channel Number	Visual Carrier Frequency (MHz)
14	471.25
15	477.25
16	483.24
17	489.25
18	495.25
19	501.25
20	507.25
21	513.25
22	519.25
23	525.25
24	531.25
25	537.25
26	543.25
27	549.25
28	555.25
29	561.25
30	567.25
31	573.25
32	579.25
33	585.25
34	591.25
35	597.25
36	603.25
37	609.25
38	615.25
39	621.25
40	627.25
41	633.25

TABLE 2: INPUT CHANNEL
OFF-AIR (UHF)

UHF BROADCAST CHANNELS	
Channel Number	Visual Carrier Frequency (MHz)
42	639.25
43	645.25
44	651.25
45	657.25
46	663.25
47	669.25
48	675.25
49	681.25
50	687.25
51	693.25
52	699.25
53	705.25
54	711.25
55	717.25
56	723.25
57	729.25
58	735.25
59	741.25
60	747.25
61	753.25
62	759.25
63	765.25
64	771.25
65	777.25
66	783.25
67	789.25
68	795.25
69	801.25

TABLE 3: OUTPUT CHANNEL CATV (2 - 42)

Output Channel Switch Setting	Visual Carrier Frequency (MHz)	Frequency Offset (kHz)
02	55.25	NONE
03	61.25	NONE
04	67.25	NONE
05	77.25	NONE
06	83.25	NONE
07	175.25	NONE
08	181.25	NONE
09	187.25	NONE
10	193.25	NONE
11	199.25	NONE
12	205.25	NONE
13	211.25	NONE
14	121.25	+12.5
15	127.25	+12.5
16	133.25	+12.5
17	139.25	NONE
18	145.25	NONE
19	151.25	NONE
20	157.25	NONE
21	163.25	NONE
22	169.25	NONE
23	217.25	NONE
24	223.25	+12.5
25	229.25	+12.5
26	235.25	+12.5
27	241.25	+12.5
28	247.25	+12.5
29	253.25	+12.5
30	259.25	+12.5
31	265.25	+12.5
32	271.25	+12.5
33	277.25	+12.5
34	283.25	+12.5
35	289.25	+12.5
36	295.25	+12.5
37	301.25	+12.5
38	307.25	+12.5
39	313.25	+12.5
40	319.25	+12.5
41	325.25	+12.5
42	331.25	+25

TABLE 4: OUTPUT CHANNEL CATV (43 - 78 and 95 - 99)

Output Channel Switch Setting	Visual Carrier Frequency (MHz)	Frequency Offset (kHz)
43	337.25	+12.5
44	343.25	+12.5
45	349.25	+12.5
46	355.25	+12.5
47	361.25	+12.5
48	367.25	+12.5
49	373.25	+12.5
50	379.25	+12.5
51	385.25	+12.5
52	391.25	+12.5
53	397.25	+12.5
54	403.25	NONE
55	409.25	NONE
56	415.25	NONE
57	421.25	NONE
58	427.25	NONE
59	433.25	NONE
60	439.25	NONE
61	445.25	NONE
62	451.25	NONE
63	457.25	NONE
64	463.25	NONE
65	469.25	NONE
66	475.25	NONE
67	481.25	NONE
68	487.25	NONE
69	493.25	NONE
70	499.25	NONE
71	505.25	NONE
72	511.25	NONE
73	517.25	NONE
74	523.25	NONE
75	529.25	NONE
76	535.25	NONE
77	541.25	NONE
78	547.25	NONE
95	91.25	NONE
96	97.25	NONE
97	103.25	NONE
98	109.25	+25
99	115.25	+25

The 550TCPT is an upgraded version of the Dracom 550TCP. The "T" Channel model includes a built-in upconverter to extend coverage of the input section to include channels T7 through T13. When the T channel upconverter module, which must be factory installed, is present, the processor may be used in either the normal mode with input channels starting at CH2 or in the T channel mode where the upconverter is connected between the input of the normal tuner and the input signal. To use the T channel mode, the included F connector jumper cable is simply installed between the **UP CONVERTER OUTPUT** and the **RF INPUT** and the T channel input signal is connected to the **T7 TO T14 IN** input instead of the **RF INPUT**. These connections are all on the rear panel of the processor. To use the processor for normal input channels, the jumper can be removed and the normal input (RF INPUT) used.

When the upconverter is used, input channel T7 is selected by choosing channel 7 on the input channel switch, T8 is selected by setting 8, and so on through input channel T13 which is selected by setting 13 on the input channel switch.

The specifications for the T series of channel processors are identical to the non T versions when used on normal channels without the input upconverter connection. When the upconverter is in use, the additional specifications, listed below, will also apply for use with T channel input channels.

These T series processors accept **T channel input** signals but **output coverage does not extend below channel 2**. Thus, T channels can be converted to any other channel in the processor's output range starting with channel 2 and up.

NOTE: When using the T channel upconverter module option on the 550TCPT, avoid use on input channels if an adjacent channel is present at the input and output. For adjacent channel operation, use the HCP1450T, HCP1550T, or HCP2550T models, which have additional SAW filtering.

UPCONVERTER SPECIFICATIONS

Gain: Unity \pm 2 dB.

Noise Figure: Less than 10 dB.

Input Level (T channels): + 30 dBmV maximum.

Input Return Loss: 15 dB typical.

Local Oscillator: 168.250 MHz, PLL synthesized and locked to processor reference.

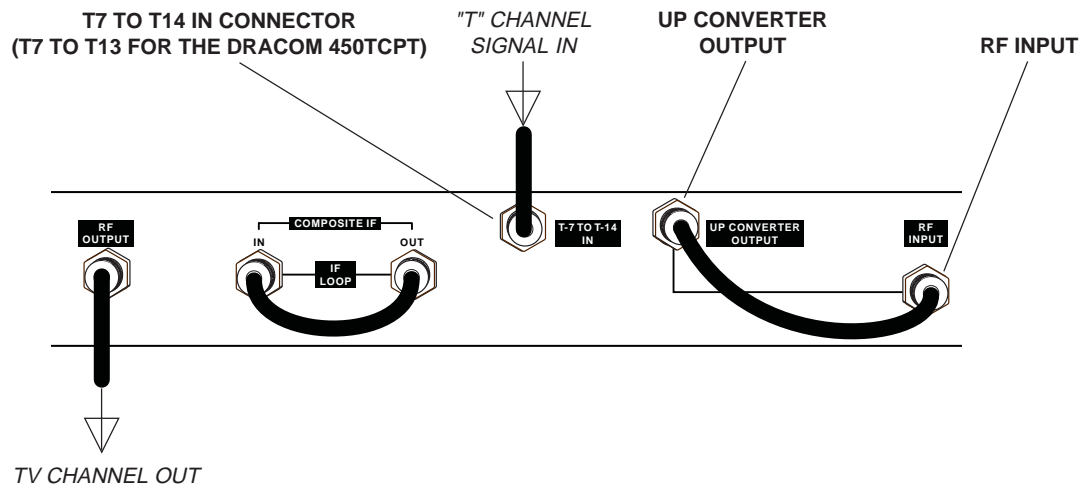

SERVICE INFORMATION

You may contact the R.L. DRAKE Service Department for additional information or assistance by calling +1 (937) 746-6990, Monday through Friday, between 8:00 A.M. and 4:00 P.M. Eastern Time, except on holidays.

You may also contact the R.L. DRAKE Service Department by E-mail at the following address:
servicehelp@rldrake.com
or by Telefax:
+1 (937) 743-4576.

Should you want to return your unit for service, package the unit carefully using the original carton or other suitable container.

Write your return address clearly on the shipping carton and on an enclosed cover letter describing the service required, symptoms or problems. Also include your daytime telephone number and a copy of your proof of purchase.

The unit will be serviced under the terms of the R.L. DRAKE COMPANY Limited Warranty and returned to you.

IF YOU NEED TO CALL FOR HELP

Call our Customer Service/Technical Support line at +1 (937) 746-6990 between 8:00 A.M. and 4:00 P.M. Eastern Time, weekdays. Please have the unit's serial number available. We will also need to know the specifics of any other equipment connected to the unit. When calling, please have the unit up and running, near the phone if possible. Our technician(s) will likely ask certain questions to aid in diagnosis of the problem. Also, have a voltmeter handy, if possible.

R.L. DRAKE also provides technical assistance by e-mail: techsupport@rldrake.com
or by Telefax: +1 (937) 743-4576.

Many of the products that are sent to us for repair are in perfect working order when we receive them. For these units, there is a standard checkout fee that you will be charged. Please perform whatever steps are applicable from the installation sections of the Owner's Manual before calling or writing—this could save unnecessary phone charges. Please do not return the unit without contacting R.L. DRAKE first: it is preferred to help troubleshoot the problem over the phone (or by mail) first, saving you both time and money.

Inside the carton, enclose a note with your name, address, daytime phone number, and a description of the unit's problem.
The unit must be sent to the following address:

**Service Department
R.L. DRAKE COMPANY
230 Industrial Drive
Franklin, Ohio 45005 U.S.A.**

Be sure to include your street address which will be needed for UPS return. UPS Surface (Brown Label) takes 7-10 days to reach us depending on your location, Blue takes 2-3 days.

Red is an overnight service. Send the unit in a way that it can be traced if we can't verify receipt of shipment. We suggest UPS or insured postal shipment.

If the unit is still under the original owner's warranty, R.L. DRAKE will pay the cost of the return shipment to you. Our return shipping policy is that we will return it UPS Brown if received Brown or by US Mail, it will be returned Blue if received Blue or Red—or it will be returned however you prefer if you furnish the return cost for the method you select.

If the unit is out of warranty, use one of the following methods for return shipment:

- 1) You designate billing to American ExPress, VISA, MasterCard or Discover card;
- 2) You prepay the service charges with a personal check, or
- 3) You specify some other method of return and payment.

When calling, the technician can estimate the repair charges for you over the phone. This is another good reason to call before sending a unit in for repair. Typically, equipment is repaired in five to ten working days after it arrives at R.L. DRAKE if we have all the facts. If we must call you, it may take longer. R.L. DRAKE is not responsible for damage caused by lightning, nonprofessional alterations, "acts of God", shipping damage, poor storage/handling, etc. R.L. DRAKE will make note of any shipping damage upon receipt.

You will need to send proof of purchase to receive warranty service. Typically, a copy of the invoice from an R.L. DRAKE dealer will suffice. The warranty is for the original owner only and is not transferable.

One Year Limited Warranty

R.L. DRAKE COMPANY warrants to the original purchaser this product shall be free from defects in material or workmanship for one (1) year from the date of original purchase.

During the warranty period the R.L. DRAKE COMPANY or an authorized Drake service facility will provide, free of charge, both parts and labor necessary to correct defects in material and workmanship. At its option, R.L. DRAKE COMPANY may replace a defective unit.

To obtain such a warranty service, the original purchaser must:

- (1) Retain invoice or original proof of purchase to establish the start of the warranty period.
- (2) Notify the R.L. DRAKE COMPANY or the nearest authorized service facility, as soon as possible after discovery of a possible defect, of:
 - (a) the model and serial number,
 - (b) the identity of the seller and the approximate date of purchase; and
 - (c) A detailed description of the problem, including details on the electrical connection to associated equipment and the list of such equipment.
- (3) Deliver the product to the R.L. DRAKE COMPANY or the nearest authorized service facility, or ship the same in its original container or equivalent, fully insured and shipping charges prepaid.

Correct maintenance, repair, and use are important to obtain proper performance from this product. Therefore carefully read the Instruction Manual. This warranty does not apply to any defect that R.L. DRAKE COMPANY determines is due to:

- (1) Improper maintenance or repair, including the installation of parts or accessories that do not conform to the quality and specifications of the original parts.
- (2) Misuse, abuse, neglect or improper installation.
- (3) Accidental or intentional damage.

All implied warranties, if any, including warranties of merchantability and fitness for a particular purpose, terminate one (1) year from the date of the original purchase.

The foregoing constitutes R.L. DRAKE COMPANY'S entire obligation with respect to this product, and the original purchaser shall have no other remedy and no claim for incidental or consequential damages, losses or expenses. Some states do not allow limitations on how long an implied warranty lasts or do not allow the exclusions or limitation of incidental or consequential damages, so the above limitation and exclusion may not apply to you.

This warranty gives you specific legal rights and you may also have other rights which vary from state to state. This warranty shall be construed under the laws of Ohio.

For Service, contact:

R.L. DRAKE COMPANY
230 Industrial Drive
Franklin, Ohio 45005 U.S.A.
Customer Service and Parts Telephone: +1 (937) 746-6990
Telefax: +1 (937) 743-4576
World Wide Web Site: <http://www.rldrake.com>



R.L. DRAKE COMPANY
230 INDUSTRIAL DRIVE
FRANKLIN, OHIO 45005 U.S.A.
CUSTOMER SERVICE AND PARTS TELEPHONE: +1 (937) 746-6990
TELEFAX: +1 (937) 743-4576
WORLD WIDE WEB SITE: <http://www.rldrake.com>