

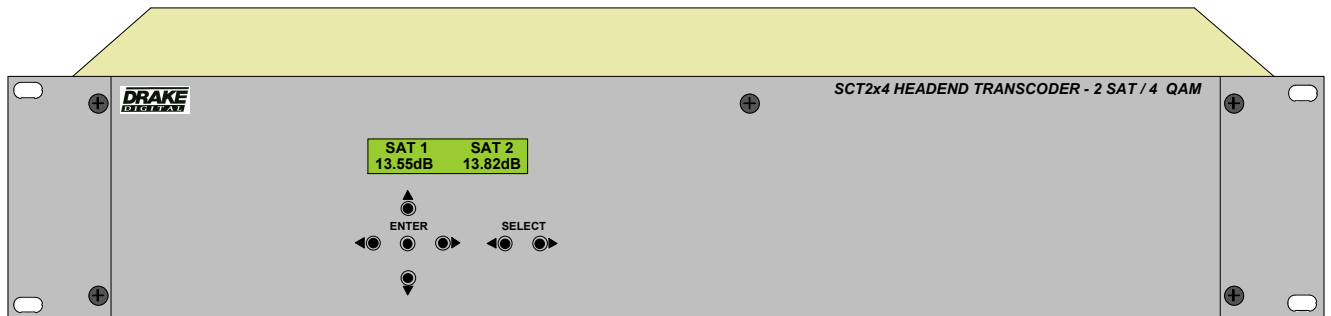

*SCT2x4 Headend Transcoder - 2 Sat / 4 QAM*

# *Instruction Manual*



## 2 Caution Statements

WARNING: TO PREVENT FIRE OR ELECTRICAL SHOCK DO NOT EXPOSE TO RAIN OR MOISTURE

	<b>CAUTION</b> RISK OF ELECTRIC SHOCK DO NOT OPEN	
CAUTION: TO REDUCE THE RISK OF ELECTRIC SHOCK, DO NOT REMOVE COVER NO USER-SERVICEABLE PARTS INSIDE REFER SERVICING TO QUALIFIED PERSONNEL		



A product and cart combination should be moved with care. Quick stops, excessive force and uneven surfaces may cause the product and cart combination to overturn.

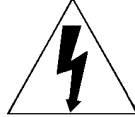

The lightning flash with arrow head symbol, within an equilateral triangle, is intended to alert the user to the presence of uninsulated "dangerous voltage" within the product's enclosure that may be of sufficient magnitude to constitute a risk of electric shock to persons.



The exclamation point within an equilateral triangle is intended to alert the user to the presence of important operating and maintenance (servicing) instructions in the literature accompanying the product.

WARNING: TO REDUCE THE RISK OF FIRE OR ELECTRIC SHOCK, DO NOT EXPOSE THIS PRODUCT TO RAIN OR MOISTURE.  
DO NOT OPEN THE CABINET, REFER SERVICING TO QUALIFIED PERSONNEL ONLY.

CAUTION: TO PREVENT ELECTRIC SHOCK, DO NOT USE THIS (POLARIZED) PLUG WITH AN EXTENSION CORD RECEPTACLE OR OTHER OUTLET UNLESS THE BLADES CAN BE FULLY INSERTED TO PREVENT BLADE EXPOSURE.

ATTENTION: POUR PREVENIR LES CHOCS ELECTRIQUES, NE PAS UTILISER CETTE FICHE POLARISEE AVEC UN PROLONGATEUR, UNE PRISE DE COURANT OU UNE AUTRE SORTIE DE COURANT, SAUF SI LES LAMES PEUVENT ETRE INSEREES A FOND SANS EN LAISSER AUCUNE PARTIE A DECOUVERT.

# Important Safety Instructions 3

## Consignes importantes de sécurité 3

**1. Read Instructions**—All the safety and operating Instructions should be read before the product is operated.

**1a. Lire les directives** - Toutes les directives de sécurité et d'utilisation devraient être lues avant de mettre l'appareil en opération.

**2. Retain Instructions**—The safety and operating instructions should be retained for future reference.

**2a. Conserver les directives** - Les directives de sécurité et d'utilisation devraient être conservées pour consultation future.

**3. Heed Warnings**—All warnings on the product and in the operating instructions should be adhered to.

**3a. Tenir compte des avertissements** - Tous les avertissements apparaissant sur l'appareil et dans les consignes d'utilisation devraient être respectés.

**4. Follow instructions** - All operating and use instructions should be followed.

**4a. Suivre les directives** - Toutes les directives d'opération et d'utilisation devraient être suivies.

**5. Cleaning**—Unplug this product from the wall outlet before cleaning. Do not use liquid cleaners or aerosol cleansers. Use a damp cloth for cleaning.

**5a. Nettoyage** - Débrancher l'appareil de la prise électrique murale avant le nettoyage. Ne pas utiliser de nettoyeurs liquides ou aérosols. Employer un linge humide pour le nettoyage.

**6. Attachments**—Do not use attachments that are not recommended by the product manufacturer as they may cause hazards.

**6a. Fixation** - Ne pas utiliser d'autres fixations que celles recommandées par le fabricant; elles pourraient être source de dangers.

**7. Water and Moisture**—Do not use this product near water—for example, near a bathtub, wash bowl, kitchen sink or laundry tub; in a wet basement; or near a swimming pool; and the like.

**7a. Eau et humidité** - Ne pas utiliser cet appareil près de l'eau. Par exemple, près d'une baignoire, d'un bac de lavage, d'un évier de cuisine ou d'une cuvette de lessivage; dans un sous-sol humide; ou à proximité d'une piscine; et autres environnements similaires.

**8. Accessories**—Do not place this product on an unstable cart, stand, tripod, bracket, or table. The product may fall, causing serious injury to a child or adult and serious damage to the product. Use only with a cart, stand, tripod, bracket, or table recommended by the manufacturer, or sold with the product. Any mounting of the product should follow the manufacturer's instructions, and should use a mounting accessory recommended by the manufacturer.

**8a. Accessoires** - Ne pas installer cet appareil sur un chariot, un socle, un trépied, un support ou une table instables. L'appareil pourrait tomber, entraînant des blessures graves à un enfant ou à un adulte, et des dommages importants à l'appareil. Employer seulement avec un chariot, un socle, un trépied, un support, ou une table recommandés par le fabricant ou vendu avec l'appareil. Toute installation de l'appareil devrait être conforme aux directives du fabricant et devrait utiliser des accessoires d'installation recommandés par celui-ci.

**9. A product and cart combination** should be moved with care. Quick stops, excessive force, and uneven surfaces may cause the product and cart combination to overturn.

**9a. Un chariot supportant l'appareil** devrait être déplacé avec précaution. Les arrêts brusques, la force excessive et les surfaces inégales peuvent renverser le chariot.

**10. Ventilation**—Slots and openings in the cabinet are provided for ventilation and to ensure reliable operation of the product and to protect it from overheating, and these openings must not be blocked or covered. The openings should never be blocked by placing the product on a bed, sofa, rug, or similar surface. This product should not be placed in a built-in installation such as bookcase or rack unless proper ventilation is provided or the manufacturer's instructions have been adhered to.

**10a. Ventilation** - Des fentes et ouvertures dans le châssis sont prévues pour la ventilation de l'appareil, pour en assurer la fiabilité d'opération et le protéger contre la surchauffe. Ces ouvertures ne doivent pas être bloquées ou recouvertes. Ces ouvertures ne devraient jamais être bloquées en plaçant l'appareil sur un lit, un sofa, une couverture, ou une surface semblable. Cet appareil ne devrait pas être installé dans un meuble encastré comme une bibliothèque ou une étagère à moins de lui fournir une ventilation adéquate ou que l'installation soit conforme aux directives du fabricant.

**11. Power Sources**—This product should be operated only from the type of power source indicated on the marking label. If you are not sure of the type of power supplied to your home, consult your product dealer or local power company. For products intended to operate from battery power, or other sources, refer to the operating instructions.

**11a. Sources d'alimentation électrique** - Cet appareil devrait être utilisé seulement avec le type d'alimentation électrique inscrite sur l'étiquette. Si vous n'êtes pas certain du type d'alimentation électrique fourni à votre maison, consultez le vendeur de l'appareil ou l'entreprises d'énergie locale. Pour des appareils alimentés par une batterie ou d'autres sources, se référer aux consignes d'utilisation.

**12. Grounding or Polarization**—This product may be equipped with a polarized alternating-current line plug (a plug having one blade wider than the other) This plug will fit into the power outlet only one way. This is a safety feature. If you are unable to insert the plug fully into the outlet, try reversing the plug. If the plug should still fail to fit, contact your electrician to replace your obsolete outlet. Do not defeat the safety purpose of the polarized plug.

**Alternate Warnings**—If this product is equipped with a three-wire grounding-type plug, a plug having a third (grounding) pin, the plug will only fit into a grounding-type power outlet. This is a safety feature. If you are unable to insert the plug into the outlet, contact your electrician to replace your obsolete outlet. Do not defeat the safety purpose of the grounding-type plug.

**12a. Mise à la terre ou polarisation** - Cet appareil peut être équipé d'une fiche électrique de courant alternatif polarisée (une fiche ayant une lame plus large que l'autre). Cette fiche ne s'insérera correctement dans la prise de courant que d'une seule façon; c'est un dispositif de sécurité. S'il est impossible d'insérer la fiche entièrement dans la prise de courant, essayer de renverser la fiche. Si la fiche ne s'insère toujours pas, contacter un électricien pour remplacer la prise de courant désuète. Ne pas altérer le dispositif de sécurité de la fiche polarisée. **Mise en garde supplémentaire** - Si cet appareil est équipé d'une fiche électrique à trois broches (une fiche ayant une broche de mise à la terre), la fiche s'insérera seulement dans une prise de courant équipée d'une mise à la terre; c'est un dispositif de sécurité. S'il est impossible d'insérer la fiche dans la prise de courant, contacter un électricien pour remplacer la prise de courant désuète. Ne pas altérer le dispositif de sécurité de la fiche avec mise à la terre.

**13. Power-Cord Protection**—Power-supply cords should be routed so that they are not likely to be walked on or pinched by items placed upon or against them, paying particular attention to cords at plugs, convenience receptacles, and the point where they exit from the product.

**13a. Protection du cordon d'alimentation** - Les cordons d'alimentation doivent être disposés de façon à ce qu'on ne puisse marcher dessus ou qu'ils soient susceptibles d'être coincés par des articles placés sur ou contre eux. Une attention particulière doit être portée aux fiches, prises de courant, et aux points où ils sortent de l'appareil.

**14. Outdoor Antenna Grounding**—If an outside antenna or cable system is connected to the product, be sure the antenna or cable system is grounded so as to provide some protection against voltage surges and built-up static charges. Article 810 of the National Electrical Code, ANSI/NFPA 70, provides information with regard to proper grounding of the mast and supporting structure, grounding of the lead-in wire to an antenna discharge unit, size of grounding conductors, location of antenna-discharge unit, connection to grounding electrodes, and requirements for the grounding electrode. See Figure A.

**14a. Mise à la terre de l'antenne extérieure** - Si un système extérieur d'antenne ou de câble est relié à l'appareil, s'assurer que le système d'antenne ou de câble est muni d'une mise à la terre afin de fournir une certaine protection contre les surtensions et les charges d'électricité statique. L'article 810 du code électrique national, ANSI/NFPA 70, fournit l'information nécessaire en ce qui concerne la mise à la terre appropriée du mât et de la structure porteuse, la mise à la terre du câble de connexion à une unité de décharge d'antenne, le calibre des conducteurs de mise à la terre, la location de l'unité de décharge d'antenne, le raccordement aux électrodes de mise à la terre et les spécifications pour les électrodes de mise à la terre.

Voir la figure A.

**15. Lightning**—For added protection for this product during a lightning storm, or when it is left unattended and unused for long periods of time, unplug it from the wall outlet and disconnect the antenna or cable system. This will prevent damage to the product due to lightning and power-line surges.

**15a. Foudre** - Pour une protection supplémentaire de cet appareil pendant un orage électrique, ou quand il est laissé sans surveillance et inutilisé pendant de longues périodes, le débrancher de la prise électrique murale et déconnecter le système d'antenne ou de câble. Ceci prévient les dommages à l'appareil dus à la foudre et aux surtensions.

**16. Power Lines**—An outside antenna system should not be located in the vicinity of overhead power lines, other electric light or power circuits, where it can fall into such power lines or circuits. When installing an outside antenna system, extreme care should be taken to keep from touching such power lines or circuits as contact with them may be fatal.

**16a. Lignes électriques** - Un système d'antenne extérieur ne devrait pas être situé à proximité de lignes électriques aériennes ou de tout autre circuit électrique, où il pourrait tomber sur de tels circuits ou lignes électriques. Lors de l'installation d'un système d'antenne extérieur, d'extrêmes précautions devraient être prises afin de prévenir tout contact avec des lignes ou circuits électriques. Entrer en contact avec de tels circuits ou lignes électriques pourrait être fatal.

**17. Overloading**—Do not overload wall outlets, extension cords, or integral convenience receptacles as this can result in a risk of fire or electric shock.

**17a. Surcharge** - Ne pas surcharger les prises de courant murales, les rallonges électriques ou les prises de courant intégrées. Un risque d'incendie ou de choc électrique pourrait résulter d'une telle surcharge.

# 4 Important Safety Instructions (cont.)

# 4 Consignes importantes de sécurité

**18. Object and Liquid Entry**—Never push objects of any kind into this product through openings as they may touch dangerous voltage points or short-out parts that could result in a fire or electric shock. Never spill liquid of any kind on the product.

**18a. Insertion d'objet ou de liquide** – Ne jamais insérer d'objet par les ouvertures de cet appareil. Il pourrait toucher des points de voltage dangereux ou court-circuiter des pièces, ce qui pourrait résulter en incendie ou en choc électrique. Ne jamais verser de liquide sur l'appareil.

**19. Servicing**—Do not attempt to service this product yourself as opening or removing covers may expose you to dangerous voltage or other hazards. Refer all servicing to qualified service personnel.

**19a. Entretien** – Ne pas essayer de faire soi-même l'entretien de cet appareil. En ouvrir ou en retirer les couvercles pourrait vous exposer à des voltages dangereux ou à d'autres dangers. Confier tout entretien à un personnel de service qualifié.

**20. Damage Requiring Service**—Unplug this product from the wall outlet and refer servicing to qualified service personnel under the following conditions:

- a. When the power-supply cord or plug is damaged,
- b. If liquid has been spilled, or objects have fallen into the product,
- c. If the product has been exposed to rain or water,
- d. If the product does not operate normally by following the operating instructions. Adjust only those controls that are covered by the operating instructions as an improper adjustment of other controls may result in damage and will often require extensive work by a qualified technician to restore the product to its normal operation,
- e. If the product has been dropped or damaged in anyway, and
- f. When the product exhibits a distinct change in performance—this indicates a need for service.

**20a. Dommage exigeant un entretien** - Débrancher cet appareil de la prise de courant électrique et confier l'entretien au personnel de service qualifié dans les éventualités suivantes:

- a. Quand le cordon d'alimentation ou sa fiche sont endommagés,
- b. Si des objets sont tombés dans l'appareil, ou si du liquide y a été renversé,
- c. Si l'appareil a été exposé à la pluie ou à l'eau,
- d. Si l'appareil ne fonctionne pas normalement en suivant les consignes d'utilisation.

Ajuster seulement les commandes qui sont mentionnées dans le guide d'opération. Un mauvais ajustement des autres commandes pourrait causer des dommages à l'appareil et souvent exiger un travail supplémentaire de la part d'un technicien qualifié pour remettre l'appareil en état normal d'opération.

**e.** Si l'appareil a été échappé ou endommagé de n'importe quelle façon, et **f.** Quand l'appareil montre un changement notable de performance – ceci indique qu'un entretien est nécessaire.

**21. Replacement Parts**—When replacement parts are required, be sure the service technician has used replacement parts specified by the manufacturer or have the same characteristics as the original part. Unauthorized substitutes may result in fire, electric shock or other hazards.

**21a. Pièces de rechange** - Si des pièces de rechange sont nécessaires, s'assurer que le technicien de service a employé des pièces de rechange spécifiques du manufacturier ou ayant les mêmes caractéristiques que les pièces originales. L'utilisation de pièces de rechange non autorisées pourrait résulter en incendie, choc électrique ou autres dangers.

**22. Safety Check**—Upon completion of any service or repairs to this product, ask the service technician to perform safety checks to determine that the product is in proper operating condition.

**22a. Vérification de sécurité** – À la suite de toute réparation ou entretien de cet appareil, demander au technicien de service d'exécuter des vérifications de sécurité afin de s'assurer que l'appareil est en condition normale de fonctionnement.

**23. Wall or Ceiling Mounting**—The product should be mounted to a wall or ceiling only as recommended by the manufacturer.

**23a. Montage au mur ou au plafond** - L'appareil ne devrait être monté au mur ou au plafond qu'uniquement de la façon recommandée par le manufacturier.

**24. Heat**—The product should be situated away from heat sources such as radiators, heat registers, stoves, or other products (including amplifiers) that produce heat.

**24a. Chaleur** – L'appareil devrait être situé loin de sources de chaleur telles que des radiateurs, des registres de chaleur, des fourneaux, ou d'autres appareils (y compris amplificateurs) produisant de la chaleur.

Figure A

Example of antenna grounding as per National Electrical Code, ANSI/NFPA 70

Exemple de mise à la terre d'antenne selon le code électrique national, ANSI/NFPA 70

**NOTE TO CATV SYSTEM INSTALLERS:**

THIS REMINDER IS PROVIDED TO CALL THE CATV SYSTEM INSTALLER'S ATTENTION TO ARTICLE 820 - 40 OF THE NEC THAT PROVIDES GUIDELINES FOR PROPER GROUNDING AND, IN PARTICULAR, SPECIFIES THAT THE CABLE GROUND SHALL BE CONNECTED TO THE GROUNDING SYSTEM OF THE BUILDING, AS CLOSE TO THE POINT OF CABLE ENTRY AS PRACTICAL.

**NOTE AUX INSTALLATEURS DE SYSTÈME DE CATV :**

CE RAPPEL EST FOURNI POUR PORTER À L'ATTENTION DES INSTALLATEURS DE SYSTÈME DE CATV, L'ARTICLE 820 - 40 DU NEC QUI DONNE DES DIRECTIVES POUR UNE MISE À LA TERRE APPROPRIÉE ET, EN PARTICULIER, SPÉCIFIE QUE LE CÂBLE DE MISE À LA TERRE DEVRAIT ÊTRE RACCORDÉ AU SYSTÈME DE MISE À LA TERRE DU BÂTIMENT LE PLUS PRÈS POSSIBLE DE L'ENTRÉE DU CÂBLE.

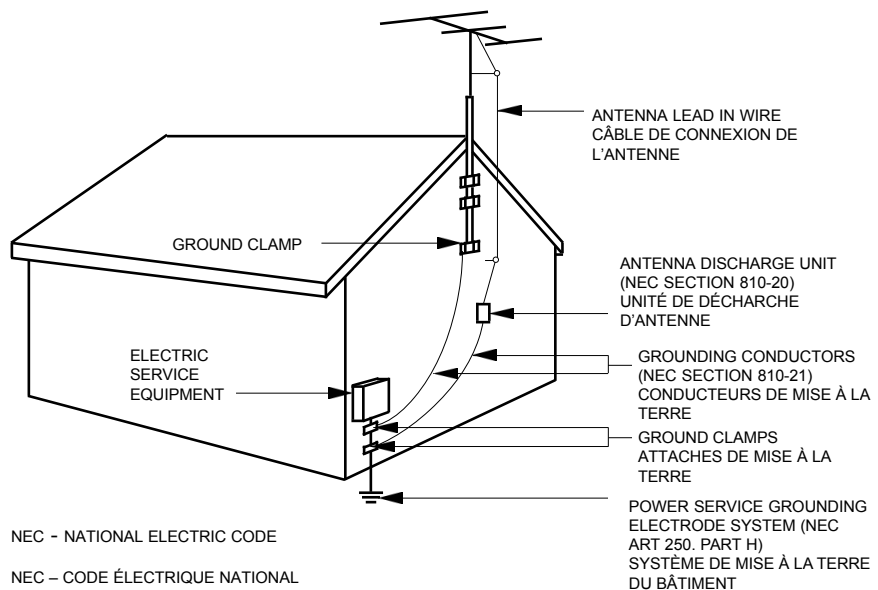

NEC - NATIONAL ELECTRIC CODE

NEC - CODE ÉLECTRIQUE NATIONAL

## TABLE OF CONTENTS

<b>2</b>	<b>Caution Statements</b>
<b>3</b>	<b>Important Safety Instructions</b>
<b>4</b>	<b>Important Safety Instructions (cont)</b>
<b>5</b>	<b>Table of Contents / Specifications</b>
<b>6</b>	<b>General Description</b>
<b>7</b>	<b>Installation and Mounting / Front Panel Controls</b>
<b>8</b>	<b>Rear Panel Connections</b>
<b>9</b>	<b>Setup and Programming / Software Flow Chart</b>
<b>10</b>	<b>Setup and Programming (continued)</b>
<b>11</b>	<b>Additional Information</b>
<b>12</b>	<b>CATV Channel Frequencies</b>
<b>13</b>	<b>HRC Channel Frequencies</b>
<b>14</b>	<b>IRC Channel Frequencies</b>
<b>15</b>	<b>Broadcast TV Channel Frequencies</b>
<b>16</b>	<b>Service / If You Need To Call For Help</b>
<b>17</b>	<b>Warranty</b>

## SPECIFICATIONS

<b>RF OUTPUT</b>	
<b>Frequency range:</b>	54 MHz to 1002 MHz. Standard CATV, HRC, IRC, or Broadcast channel plans are supported.
<b>Frequency stability:</b>	± 5 ppm
<b>Phase noise:</b>	- 101 dBc/Hz @ 10 kHz offset
<b>Output level:</b>	+ 55 dBmV / channel.
<b>Output level display accuracy:</b>	± 1 dB
<b>Output level stability:</b>	± 1 dB
<b>Output level adjustment range:</b>	+ 45 dBmV to + 56 dBmV nominal output level.
<b>Output impedance:</b>	75 ohm, return loss = 14 dB
<b>Modulation modes:</b>	CW, QAM - 16A, 32A, 64A, 128A, 256A, 512A, 1024A, 64B, 256B, 1024B
<b>QAM symbol rate:</b>	1 MS/s to 7 MS/s
<b>Spurious:</b>	- 60 dBc, 5 MHz to 1002 MHz
<b>Broadband noise:</b>	- 69 dBc @ 6 MHz bandwidth, equivalent to - 75 dBc for a single channel.
<b>QAM I/Q phase error:</b>	< 1 degree.
<b>Channel amplitude error:</b>	< 1 dB.
<b>Carrier suppression:</b>	> 45 dB
<b>MER:</b>	> 40 dB with blind equalizer.
<b>SATELLITE INPUTS</b>	
<b>Frequency range:</b>	950 MHz to 2150 MHz
<b>Input impedance:</b>	75 ohm, return loss = 10 dB
<b>Input level range:</b>	- 25 dBm to - 65 dBm / transponder.
<b>Input level matching:</b>	Input levels between the two inputs should be within 15 dB for optimum performance.
<b>Mode:</b>	QPSK, 8PSK
<b>FEC:</b>	DVB-S2.
<b>Symbol rate:</b>	2 MS/s to 30 MS/s
<b>LNB power:</b>	+18V ± 10%, 500 mA maximum total of both inputs.
<b>ASI OUTPUTS</b>	
<b>Impedance:</b>	75 ohms
<b>Data rate:</b>	270 Mb/s.
<b>ASI INPUT</b>	
<b>Impedance:</b>	75 ohm
<b>Data rate:</b>	270 Mb/s
<b>Cable length:</b>	1000 ft. maximum
<b>RS232</b>	
<b>Data rate:</b>	2400, 4800, 9600, or 19200 baud.
<b>Maximum loop length:</b>	10 units
<b>GENERAL</b>	
<b>Power:</b>	90 to 132 VAC / 60 Hz, 85 Watts.
<b>Size:</b>	19" W x 3.5" H x 21.5" D
<b>Weight:</b>	16 pounds
<b>Operating temperature:</b>	0 to + 50 degrees Celsius

# 6 General Description

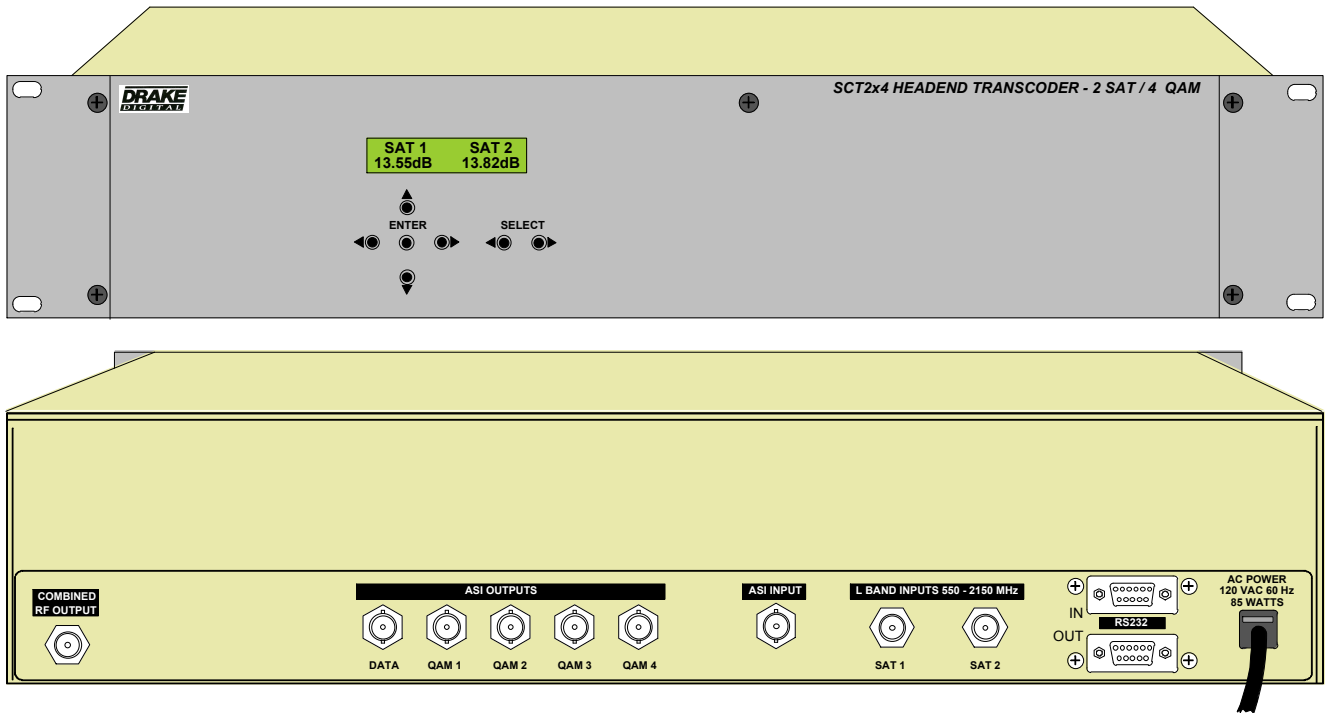

## GENERAL DESCRIPTION

### 2 SATELLITE DEMODS

The SCT2X4 is a Satellite to Cable Transcoder that includes two satellite tuners and demodulators that are independently tuned and demodulate two satellite transponders. Each tuner has its own L band input so that choices are not limited to one polarity or satellite.

The SCT2X4 is designed mainly to recover MPEG2 or H.264 video from the satellite downlinked transmissions. This model is configured to receive 8PSK modulation with DVB-S2 FEC.

### X MULTIPLEXING AND GROOMING

After demodulation, the correct programs will be directed to the correct QAM channels automatically based upon the transponder selection. SAT 1 programs are directed to QAM1 and QAM 2 while SAT 2 programs are directed to QAM3 and QAM 4.

### 4 QAM MODULATORS

The data rates are such that when the satellite transmissions are 8PSK with DVB-S2 FEC, the programs from two transponders will usually require four QAM output channels if all programs are selected. Four high performance QAM modulators, with up to + 55 dBmV output level per QAM, after combining of the 4 QAMs, are included.

The SCT2X4 does not alter the scrambling that is likely to be in place on the program streams. The scrambled streams pass intact through the transcoder and are delivered to the set top box where the descrambling will occur.

The SCT2X4 does provide a data output that can be used to direct satellite delivered data, such as EMM streams, to the local headend. This output is active only if your system is designed to use this feature.

The SCT2X4 also provides an ASI input where additional locally generated programs can be input. This input is only usable if your system is designed to use this feature.

The SCT2X4 may be remotely monitored and controlled via its RS232 interface.

## INSTALLATION AND MOUNTING NOTES

This equipment is designed to be installed in a standard 19" rack. When the unit is mounted above or below other rack mounted equipment, a 1U space (1.75") should be left between the unit and the other equipment to allow ambient air flow between the units. **No space is needed between adjacent SCT2x4 units themselves** due to the ventilation provided by their built in fans.

Connect the AC line cord to an appropriate source of 120 volt, 50/60 Hz AC power. The SCT2x4 is always on once the AC power cord is connected to its power source.

## FRONT PANEL CONTROLS

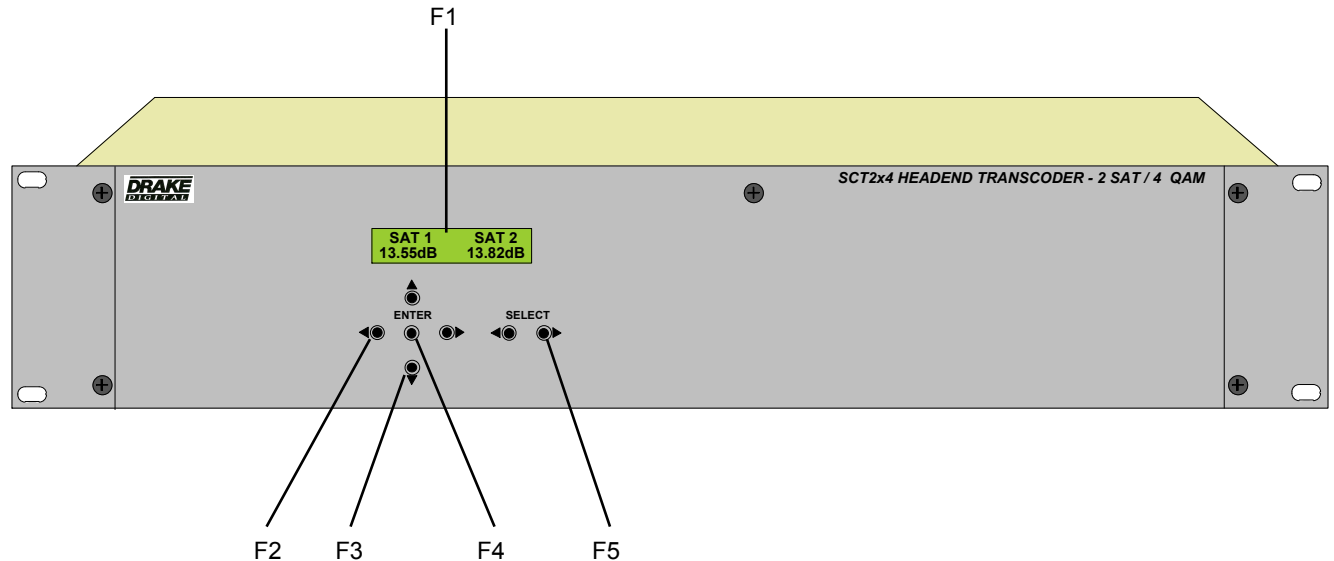

**F1, LCD Display** - This display presents the selected menu screen and the parameter settings. The backlight in the display is on when power is applied.

**F2, ◀ Left and ▶ Right Buttons** – Use the left and right arrow buttons to navigate from screen to screen to view a parameter setting within a particular program group. These buttons are operational in the view mode or the adjust mode. Using only these buttons will not change any parameter setting.

**F3, ▲ Up and ▼ Down Buttons** – Use the up and down arrow buttons to change the value of a viewed parameter setting. The unit must be in the adjust mode in order for these buttons to become active for changing a parameter setting. If the unit is not in the adjust mode and program group 'INPUTS' has been selected using the 'SELECT ◀ Left and ▶ Right Buttons (F5), pressing the UP button will toggle between the 'SAT 1 SAT 2' screen and the 'FW Version' screen. Pressing the DOWN button will toggle between the 'SAT 1 SAT 2' screen and the 'STAT2 STAT3' screens. If QAM 1 through QAM 4 have been selected, pressing the UP button will display the firmware version number, but pressing DOWN button will display the Buffer screen showing the percentage of current buffer usage on the left and maximum buffer usage on the right for that particular QAM output.

**F4, ENTER Button** - Use the ENTER button to enter the

adjust mode or to save and load a new setting or settings after adjustment. Hold for approximately 2 seconds until the bottom line of the display starts to flash to enter the adjust mode. After entering the adjust mode, momentarily pressing the ENTER button again will load and save any settings that may have been changed using the Up and Down buttons.

**F5, ◀ Left and ▶ Right SETUP SELECT Buttons** - Use the left and right SETUP SELECT buttons to navigate through the 7 available programming groups. The selection of the desired parameters within each of these groups can then be made using the LEFT and RIGHT (F2), UP and DOWN (F3), and ENTER (F4) buttons. These groups are as follows:

**INPUTS** - Allows observation and selection of several parameters for the SAT 1 and SAT 2 inputs.

**QAM 1, QAM 2, QAM 3, & QAM 4** - Allows observation and selection of parameters for each of the four QAM outputs.

## 8 Rear Panel Connections

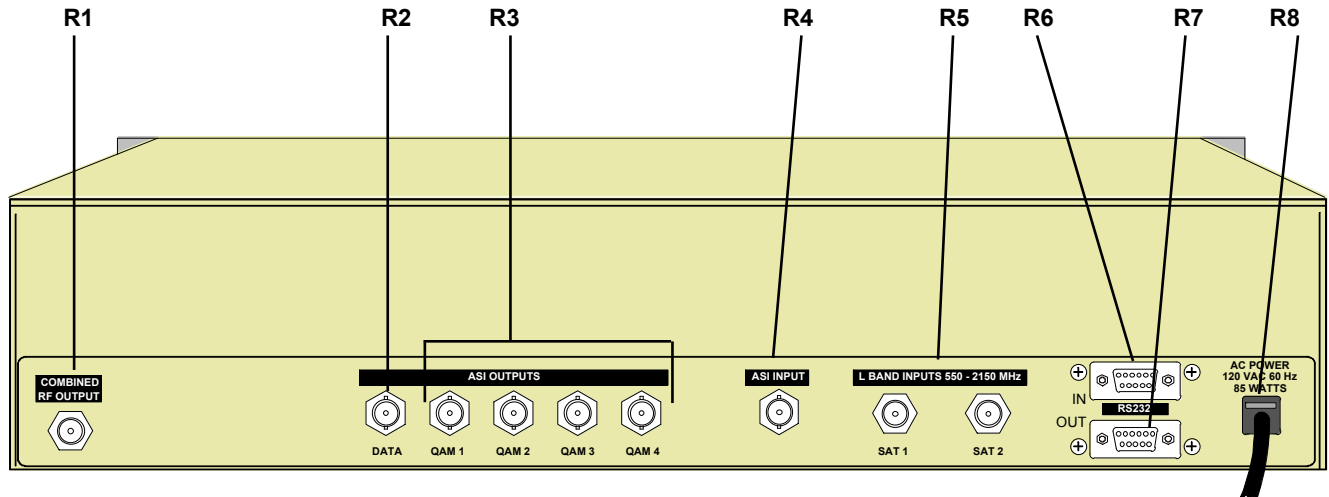

### REAR PANEL CONNECTIONS

**R1, RF OUTPUT** – This type "F" connector is the high level (+55 dBmV), 54 to 1002 MHz, output from the SCT2x4 upconverter section.

**R2, DATA ASI OUTPUT** - This BNC type connector provides a data output that can be used to direct satellite delivered data such as EMM streams to the local headend. May not be used in your system.

**R3, QAM1, QAM2, QAM3, & QAM4 ASI OUTPUTS** - These four BNC type connectors deliver the same four QAM multiprogram transport streams that are fed to the RF OUTPUT.

**R4, ASI INPUT** - This BNC type connector provides an ASI input where additional locally generated programs can be input. May not be used in your system.

**R5, L BAND SAT1 and SAT 2 INPUTS** - These "F" type connectors provide connection to two separate LNBS for

satellite input. The user may determine if LNB voltage is supplied through these connectors as determined by software settings.

**R6, RS232 IN** - Connection to a PC or modem for use with remote control / monitoring program or for firmware download.

**R7, RS232 OUT** - Loop to another SCT2X4 or other RS232 controllable device.

**R8, AC Line Cord** – For connection to the nominal 120 VAC power source. This unit is designed for use in countries with 120 VAC power standards but the power supply will accept an input voltage range of 90 VAC minimum to 260 VAC maximum with a power line frequency of either 50 or 60 Hz. The maximum power consumption is 85 watts.



Programming and viewing of the various setup and operating parameters is accomplished using the front panel back lit, two line, sixteen character wide LCD along with the two LEFT and RIGHT SELECT buttons and the five LEFT, RIGHT, UP, DOWN and ENTER buttons. The name of the parameter is on the top line of the display and the setting value is on the bottom line.

To observe a certain parameter setting without intending to change its value, just use the LEFT and RIGHT SELECT buttons and the LEFT and RIGHT arrow buttons to navigate through the menus shown in the software flow chart below. The current setting for each parameter is shown on the bottom line of the display. Note that depending upon certain settings, some screens are not needed and will be skipped.

To make a change in the displayed parameter and its setting and if this is the initial setup, you will want to enter the 'adjust' mode. To do this, press the ENTER button that is located in the center of the four arrow buttons and hold in for several seconds until the bottom line of the display begins to flash.

After you are in the adjust mode (bottom line of screen flashing) use the LEFT and RIGHT arrows to navigate among screens and use the UP and DOWN arrows to change the parameter setting. When ENTER is pressed, the new settings will be loaded and stored and the unit will exit the 'adjust' mode. You may wish to not press ENTER until you have gone through all screens and settings and then press ENTER to save and load all changes in one step, OR you can store just one or several parameters at a time and reenter adjust mode to set the next. Either method is acceptable.

## SCT2x4 HEADEND TRANSCODER SOFTWARE FLOW CHART

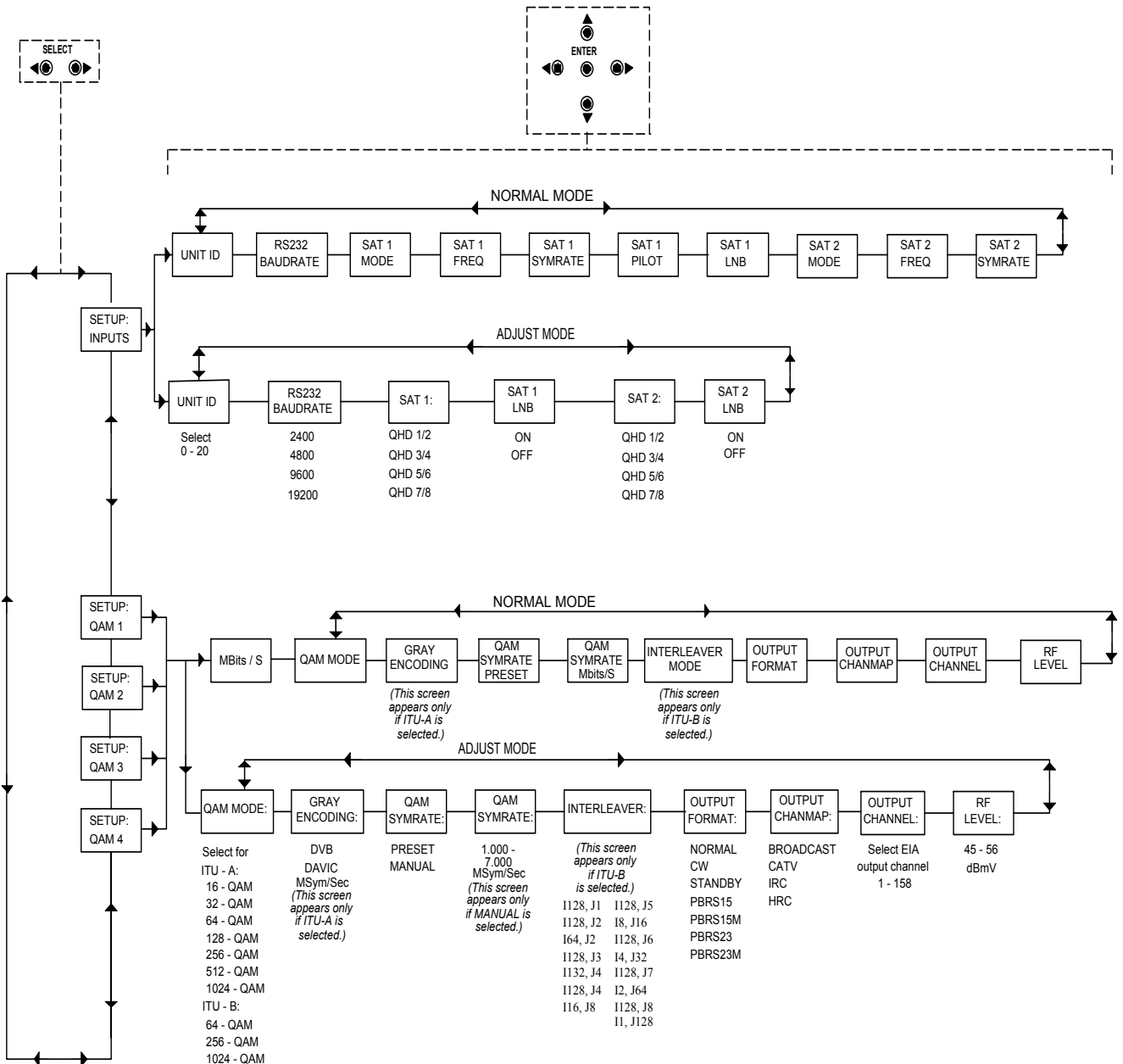

## 10 Setup and Programming (continued)

This section provides additional details regarding the selectable items shown in the 'adjust' mode on the Software Flow Chart on page 9.

### SETUP: INPUTS

**UNIT ID:** Select the desired unit identification number when connecting the 'RS232 IN' connector to a PC or modem for remote control using 'Drake Remote Control Software'. Numbers 1 thru 63 may be used. If zero (0) is selected, the PC will ignore the unit.

**RS232 BAUD RATE:** This setting determines the baud rate at which the SCT2x4 communicates with the remote PC. Settings available are 2400, 4800, 9600 and 19,200. All units 'daisy chained' to the remote PC or modem must be set to the same baud rate.

**SAT 1 and SAT 2:** These menu items provide means for selecting the desired preprogrammed satellite and transponder on the SAT 1 and SAT 2 inputs. Each selection automatically programs the correct transponder frequency as well as mode and symrate into the SCT2x4.

**SAT 1 and SAT 2 LNB:** The SCT2x4 receives its input signal from the IF outputs of two independent LNBS connected to the SAT1 and SAT 2 inputs. Each of these inputs is capable of providing power to the LNB. However, in some situations where an LNB output is split among several other devices, it may be undesirable for the SCT2x4 to provide LNB power. These menu entries provide the means of turning off LNB power to one or both SAT inputs for these situations.

### SETUP: QAM 1,2,3 & 4

**QAM MODE:** This menu allows the user to set the modulation type for the output. Choices range from QAM-16A through QAM-1024B. 'A' suffixes indicate DVB compliant FEC and the B suffixes indicate DigiCipher II FEC encoding. Note that the output QAM mode usually must be QAM-256. For CATV systems using DigiCipher II, select the QAM-256B mode. For DISH Network QAM distribution or other DVB systems using DVB set tops, choose the QAM-256A mode.

**GRAY ENCODING:** This menu is only available when QAM modes QAM-16A through QAM-1024A, are selected. The choices are DVB and DAVIC. Gray Encoding is normally not used for video data.

**QAM SYMRATE: Preset or Manual:** If PRESET is selected, the symbol rate will be automatically set to the 'normal' rate based on the QAM mode that is selected and assuming a 6 MHz wide QAM channel. If MANUAL is selected, pressing the right or left arrow buttons will allow selection of symrates from 1.000 thru 7.000 MSym/Sec.

**QAM SYMRATE:** This menu item only appears if 'Manual' is selected in the previously described menu item. It allows selection of the output QAM baudrate or symbol rate. Set as required by the set top box.

**INTERLEAVER:** This menu item only appears if QAM-64B, QAM-256B, or QAM-1024B is selected and provides the means to set the QAM modulator interleaver. Choose among the available selections based upon your system / set top box requirements. For typical 256-QAM DigiCipher II CATV systems, I128, J1 is the most commonly used interleave setting but many other choices are available. This menu does not appear in the adjust mode if the QAM mode is A (DVB) as there is only one choice in the DVB standard.

**OUTPUT FORMAT:** For normal operation, select NORMAL. For system level set up, choose CW to provide a CW carrier at the center frequency of the output channel for use in leveling a system when a QAM power meter is not available. To disable all RF output, select STANDBY. In the CW mode, the CW carrier can be measured on a spectrum analyzer without a need to apply a bandwidth correction or it can be measured with an analog meter tuned to channel center. The CW power measured will equal the channel QAM power when the modulator is returned to NORMAL output mode. Usually QAM signals are set 5 dB to 10 dB below analog NTSC channels when balancing a system.

PRBS menu entries are used for testing purposes only and should normally not be selected by the user.

**OUTPUT CHANMAP, OUTPUT CHANNEL:** Select the desired EIA CATV channel output using these two menus.

**RF LEVEL:** Select the desired RF output signal level. The available range is between +45 dBmV and +56 dBmV, selectable in 0.5 dB steps. The output accuracy is  $\pm 1$  dB.

## ADDITIONAL INFORMATION

### STANDBY MODE

The SCT2x4 has a standby output mode which turns off the RF output. This can be used when it is desirable to temporarily disable the output without unplugging the AC line cord. Select STANDBY in the OUTPUT FORMAT menu.

### OVER TEMPERATURE SENSOR

Temperature monitoring is built into this product. If inadequate ventilation is provided, overheating may occur. If this condition is detected, the default LCD message will change to OVER TEMP. If this occurs, the problem should be corrected as soon as possible. The unit will remain operational but the ventilation must be restored to prevent premature part failures due to overheating.

### STATUS DISPLAYS

When the units are not in the adjust mode, status displays are shown. When the LEFT and RIGHT SELECT buttons are used to select INPUT, SAT CHANNELS, or ASI CHANNELS, the default display shows the signal to noise ratio expressed in dB of the SAT 1 and SAT 2 inputs. Pressing the UP button will show the firmware version number.

If the SELECT buttons are used to select QAM1, 2, 3, or 4, the default screen will show the percentage of buffer capacity that is currently in use on the left side of the display

and the maximum percentage of buffer capacity that has occurred since the unit was last programmed on the right side, for the QAM output selected.

Pressing the up arrow button will show the firmware version number, and pressing the down button will show the QAM SYMRATE in MBits/Second for the QAM number selected.

### REMOTE CONTROL AND MONITORING

The SCT2x4 may be used with the Drake SCTeci or with the 'Drake Digital Headend Remote Control Software' program to allow remote monitoring or control. Only version **tbd** or newer of the software is compatible with the SCT2x4.

Connect the RS232 cable coming from the SCTeci, PC, or modem to the RS232 IN DB9 rear panel connector.

Assign a UNIT ID (1 to 63) to use the remote program. Leave at, or set to, 0 if no remote access is desired.

Set the RS232 BAUD RATE to match the PC setting.

If you are familiar with the SCTeci or the Drake Software Program, operation will be clear. If not familiar with them, see further instructions in the insert provided with the CDROM or stored on the CDROM, or the SCTeci instructions.

# 12 CATV Channel Frequencies

TABLE 1: CATV

CABLE TV CHANNELS	
Channel Number	Center of Channel
EIA/NCTA Numeric Equivalent	Frequency in MHz
2	57
3	63
4	69
5	79
6	85
95	93
96	99
97	105
98	111
99	117
14	123
15	129
16	135
17	141
18	147
19	153
20	159
21	165
22	171
7	177
8	183
9	189
10	195
11	201
12	207
13	213
23	219
24	225
25	231
26	237
27	243
28	249
29	255
30	261
31	267
32	273
33	279
34	285
35	291
36	297
37	303
38	309
39	315
40	321

CABLE TV CHANNELS	
Channel Number	Center of Channel
EIA/NCTA Numeric Equivalent	Frequency in MHz
41	327
42	333
43	339
44	345
45	351
46	357
47	363
48	369
49	375
50	381
51	387
52	393
53	399
54	405
55	411
56	417
57	423
58	429
59	435
60	441
61	447
62	453
63	459
64	465
65	471
66	477
67	483
68	489
69	495
70	501
71	507
72	513
73	519
74	525
75	531
76	537
77	543
78	549
79	555
80	561
81	567
82	573
83	579
84	585
85	591

CABLE TV CHANNELS	
Channel Number	Center of Channel
EIA/NCTA Numeric Equivalent	Frequency in MHz
86	597
87	603
88	609
89	615
90	621
91	627
92	633
93	639
94	645
100	651
101	657
102	663
103	669
104	675
105	681
106	687
107	693
108	699
109	705
110	711
111	717
112	723
113	729
114	735
115	741
116	747
117	753
118	759
119	765
120	771
121	777
122	783
123	789
124	795
125	801
126	807
127	813
128	819
129	825
130	831
131	837
132	843
133	849
134	855
135	861

**TABLE 2: HRC**

HRC TV CHANNELS	
Channel Number	Center of Channel
EIA/NCTA Numeric Equivalent	Frequency in MHz
2	55.75
3	61.75
4	67.75
1	73.75
5	79.75
6	85.75
95	91.75
96	97.75
97	103.75
98	109.75
99	115.75
14	121.75
15	127.75
16	133.75
17	139.75
18	145.75
19	151.75
20	157.75
21	163.75
22	169.75
7	175.75
8	181.75
9	187.75
10	193.75
11	199.75
12	205.75
13	211.75
23	217.75
24	223.75
25	229.75
26	235.75
27	241.75
28	247.75
29	253.75
30	259.75
31	265.75
32	271.75
33	277.75
34	283.75
35	289.75
36	295.75
37	301.75
38	307.75
39	313.75
40	320.75
41	325.75
42	331.75
43	337.75
44	343.75
45	349.75
46	355.75
47	361.75
48	367.75

HRC TV CHANNELS	
Channel Number	Center of Channel
EIA/NCTA Numeric Equivalent	Frequency in MHz
49	373.75
50	379.75
51	385.75
52	391.75
53	397.75
54	403.75
55	409.75
56	415.75
57	421.75
58	427.75
59	433.75
60	439.75
61	445.75
62	451.75
63	457.75
64	463.75
65	469.75
66	475.75
67	481.75
68	487.75
69	493.75
70	499.75
71	505.75
72	511.75
73	517.75
74	523.75
75	529.75
76	535.75
77	541.75
78	547.75
79	553.75
80	559.75
81	565.75
82	571.75
83	577.75
84	583.75
85	589.75
86	595.75
87	601.75
88	607.75
89	613.75
90	619.75
91	625.75
92	631.75
93	637.75
94	643.75
100	649.75
101	655.75
102	661.75
103	667.75
104	673.75
105	679.75
106	685.75

HRC TV CHANNELS	
Channel Number	Center of Channel
EIA/NCTA Numeric Equivalent	Frequency in MHz
107	691.75
108	697.75
109	703.75
110	709.75
111	715.75
112	721.75
113	727.75
114	733.75
115	739.75
116	745.75
117	751.75
118	757.75
119	763.75
120	769.75
121	775.75
122	781.75
123	787.75
124	793.75
125	799.75
126	805.75
127	811.75
128	817.75
129	823.75
130	829.75
131	835.75
132	841.75
133	847.75
134	853.75
135	859.75
136	865.75
137	871.75
138	877.75
139	883.75
140	889.75
141	895.75
142	901.75
143	907.75
144	913.75
145	919.75
146	925.75
147	931.75
148	937.75
149	943.75
150	949.75
151	955.75
152	961.75
153	967.75
154	973.75
155	979.75
156	985.75
157	991.75
158	997.75

# 14 IRC Channel Frequencies

TABLE 3: IRC

IRC TV CHANNELS	
Channel Number	Center of Channel
EIA/NCTA Numeric Equivalent	Frequency in MHz
2	57.00
3	63.00
4	69.00
1	75.00
5	81.00
6	87.00
95	93.00
96	99.00
97	105.00
98	111.00
99	117.00
14	123.00
15	129.00
16	135.00
17	141.00
18	147.00
19	153.00
20	159.00
21	165.00
22	171.00
7	177.00
8	183.00
9	189.00
10	195.00
11	201.00
12	207.00
13	213.00
23	219.00
24	225.00
25	231.00
26	237.00
27	243.00
28	249.00
29	255.00
30	261.00
31	267.00
32	273.00
33	279.00
34	285.00
35	291.00
36	297.00
37	303.00
38	309.00
39	315.00
40	321.00
41	327.00
42	333.00
43	339.00
44	345.00
45	351.00
46	357.00
47	363.00
48	369.00

IRC TV CHANNELS	
Channel Number	Center of Channel
EIA/NCTA Numeric Equivalent	Frequency in MHz
49	375.00
50	381.00
51	387.00
52	393.00
53	399.00
54	405.00
55	411.00
56	417.00
57	423.00
58	429.00
59	435.00
60	441.00
61	447.00
62	453.00
63	459.00
64	465.00
65	471.00
66	477.00
67	483.00
68	489.00
69	495.00
70	501.00
71	507.00
72	513.00
73	519.00
74	525.00
75	531.00
76	537.00
77	543.00
78	549.00
79	555.00
80	561.00
81	567.00
82	573.00
83	579.00
84	585.00
85	591.00
86	597.00
87	603.00
88	609.00
89	615.00
90	621.00
91	627.00
92	633.00
93	639.00
94	645.00
100	651.00
101	657.00
102	663.00
103	669.00
104	675.00
105	681.00
106	687.00

IRC TV CHANNELS	
Channel Number	Center of Channel
EIA/NCTA Numeric Equivalent	Frequency in MHz
107	693.00
108	699.00
109	705.00
110	711.00
111	717.00
112	723.00
113	729.00
114	735.00
115	741.00
116	747.00
117	753.00
118	759.00
119	765.00
120	771.00
121	777.00
122	783.00
123	795.00
124	795.00
125	801.00
126	807.00
127	813.00
128	819.00
129	825.00
130	831.00
131	837.00
132	843.00
133	849.00
134	855.00
135	861.00
136	867.00
137	873.00
138	879.00
139	885.00
140	891.00
141	897.00
142	903.00
143	909.00
144	915.00
145	921.00
146	927.00
147	933.00
148	939.00
149	945.00
150	951.00
151	957.00
152	963.00
153	969.00
154	975.00
155	981.00
156	987.00
157	993.00
158	999.00

**TABLE 2: BC TV**

VHF BROADCAST CHANNELS	
Channel Number	Center of Channel Frequency (MHz)
2	57
3	63
4	69
5	79
6	85
7	177
8	183
9	189
10	195
11	201
12	207
13	213

UHF BROADCAST CHANNELS	
Channel Number	Center of Channel Frequency (MHz)
14	473
15	479
16	485
17	491
18	497
19	503
20	509
21	515
22	521
23	527
24	533
25	539
26	545
27	551
28	557
29	563
30	569
31	575
32	581
33	587
34	593
35	599
36	605
37	611
38	617
39	623
40	629
41	635
42	641
43	647
44	653
45	659
46	665
47	671
48	677
49	683
50	689
51	695
52	701
53	707
54	713
55	719
56	725
57	731
58	737
59	743
60	749
61	755
62	761
63	767
64	773
65	779
66	785
67	791
68	797
69	803

# 16 Service / If You Need To Call For Help

## SERVICE INFORMATION

You may contact the R.L. DRAKE Service Department for additional information or assistance by calling +1 (937) 746-6990, Monday through Friday, between 8:00 A.M. and 4:00 P.M. Eastern Time, except on holidays.

You may also contact the R.L. DRAKE Service Department by E-mail at the following address:  
TechSupport@rldrake.com  
or by Telefax:  
+1 (937) 806-1576.

Should you want to return your unit for service, package the unit carefully using the original carton or other suitable container.

Write your return address clearly on the shipping carton and on an enclosed cover letter describing the service required, symptoms or problems. Also include your daytime telephone number and a copy of your proof of purchase.

The unit will be serviced under the terms of the R.L. DRAKE LLC Limited Warranty and returned to you.

## IF YOU NEED TO CALL FOR HELP

Call our Customer Service/Technical Support line at +1 (937) 746-6990 between 8:00 A.M. and 4:00 P.M. Eastern Time, weekdays. Please have the unit's serial number available. We will also need to know the specifics of any other equipment connected to the unit. When calling, please have the unit up and running, near the phone if possible. Our technician(s) will likely ask certain questions to aid in diagnosis of the problem. Also, have a voltmeter handy, if possible.

R.L. DRAKE also provides technical assistance by e-mail: TechSupport@rldrake.com  
or by Telefax: +1 (937) 806-1576.

Many of the products that are sent to us for repair are in perfect working order when we receive them. For these units, there is a standard checkout fee that you will be charged. Please perform whatever steps are applicable from the installation sections of the Owner's Manual before calling or writing—this could save unnecessary phone charges. Please do not return the unit without contacting R.L. DRAKE first: it is preferred to help troubleshoot the problem over the phone (or by mail) first, saving you both time and money.

Inside the carton, enclose a note with your name, address, daytime phone number, and a description of the unit's problem.  
The unit must be sent to the following address:

**Service Department  
R.L. DRAKE LLC  
230 Industrial Drive  
Franklin, Ohio 45005 U.S.A.**

Be sure to include your street address which will be needed for UPS return. UPS Surface (Brown Label) takes 7-10 days to reach us depending on your location, Blue takes 2-3 days.

Red is an overnight service. Send the unit in a way that it can be traced if we can't verify receipt of shipment. We suggest UPS or insured postal shipment.

If the unit is still under the original owner's warranty, R.L. DRAKE will pay the cost of the return shipment to you. Our return shipping policy is that we will return it UPS Brown if received Brown or by US Mail, it will be returned Blue if received Blue or Red—or it will be returned however you prefer if you furnish the return cost for the method you select.

If the unit is out of warranty, use one of the following methods for return shipment:

- 1) You designate billing to American Express, VISA, MasterCard or Discover card;
- 2) You prepay the service charges with a personal check, or
- 3) You specify some other method of return and payment.

When calling, the technician can estimate the repair charges for you over the phone. This is another good reason to call before sending a unit in for repair. Typically, equipment is repaired in five to ten working days after it arrives at R.L. DRAKE if we have all the facts. If we must call you, it may take longer. R.L. DRAKE is not responsible for damage caused by lightning, nonprofessional alterations, "acts of God", shipping damage, poor storage/handling, etc. R.L. DRAKE will make note of any shipping damage upon receipt.

You will need to send proof of purchase to receive warranty service. Typically, a copy of the invoice from an R.L. DRAKE dealer will suffice. The warranty is for the original owner only and is not transferable.



## Three Year Limited Warranty

R.L. DRAKE LLC warrants to the original purchaser this product shall be free from defects in material or workmanship for three (3) years from the date of original purchase.

During the warranty period the R.L. DRAKE LLC or an authorized Drake service facility will provide, free of charge, both parts and labor necessary to correct defects in material and workmanship. At its option, R.L. DRAKE LLC may replace a defective unit.

To obtain such a warranty service, the original purchaser must:

- (1) Retain invoice or original proof of purchase to establish the start of the warranty period.
- (2) Notify the R.L. DRAKE LLC or the nearest authorized service facility, as soon as possible after discovery of a possible defect, of:
  - (a) the model and serial number,
  - (b) the identity of the seller and the approximate date of purchase; and
  - (c) A detailed description of the problem, including details on the electrical connection to associated equipment and the list of such equipment.
- (3) Deliver the product to the R.L. DRAKE LLC or the nearest authorized service facility, or ship the same in its original container or equivalent, fully insured and shipping charges prepaid.

Correct maintenance, repair, and use are important to obtain proper performance from this product. Therefore carefully read the Instruction Manual. This warranty does not apply to any defect that R.L. DRAKE LLC determines is due to:

- (1) Improper maintenance or repair, including the installation of parts or accessories that do not conform to the quality and specifications of the original parts.
- (2) Misuse, abuse, neglect or improper installation.
- (3) Accidental or intentional damage.

All implied warranties, if any, including warranties of merchantability and fitness for a particular purpose, terminate three (3) years from the date of the original purchase.

The foregoing constitutes R.L. DRAKE LLC'S entire obligation with respect to this product, and the original purchaser shall have no other remedy and no claim for incidental or consequential damages, losses or expenses. Some states do not allow limitations on how long an implied warranty lasts or do not allow the exclusions or limitation of incidental or consequential damages, so the above limitation and exclusion may not apply to you.

This warranty gives you specific legal rights and you may also have other rights which vary from state to state. This warranty shall be construed under the laws of Ohio.

For Service, contact:

**R.L. DRAKE LLC**  
230 Industrial Drive  
Franklin, Ohio 45005 U.S.A.  
**Customer Service and Parts Telephone:** +1 (937) 746-6990  
**Telefax:** +1 (937) 806-1576  
**World Wide Web Site:** <http://www.rldrake.com>



**R.L. Drake LLC**

230 Industrial Drive

Franklin, Ohio 45005 U.S.A.

**Customer Service and Parts Telephone:** +1 (937) 746-6990

**Telefax:** +1 (937) 806-1576

**World Wide Web Site:** <http://www.rldrake.com>